

A24 BEVEL GEAR ISO

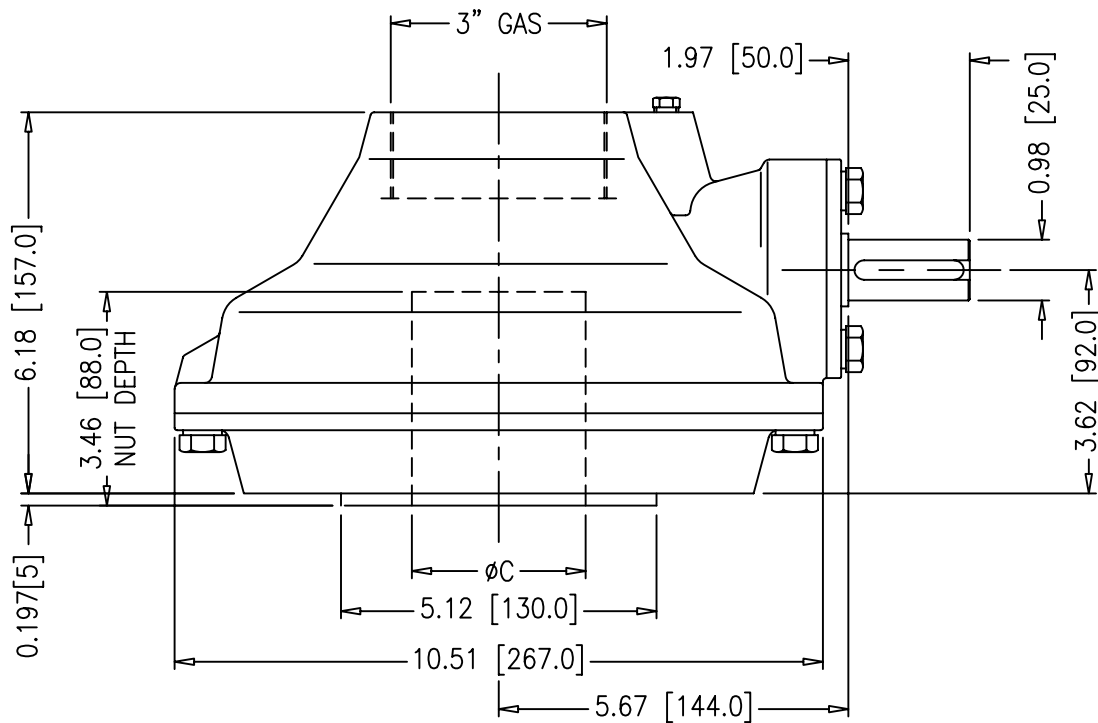

M20 TAP~ 4 HOLES
ON A 6.50 [165.0] B.C.D.

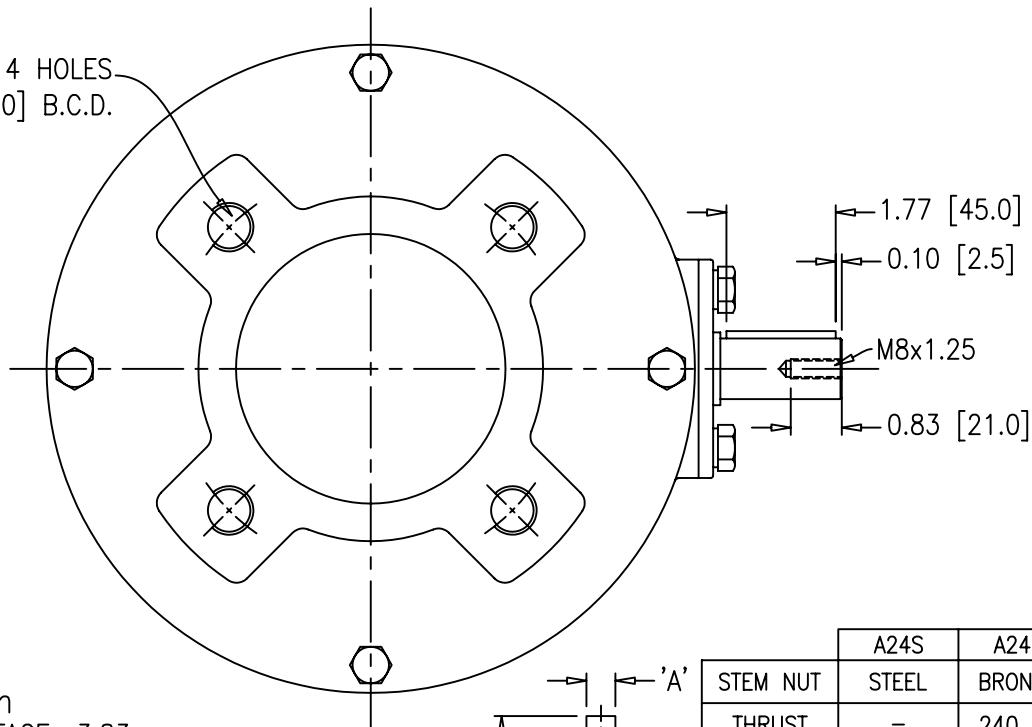

NOTES:

1. TORQUE: 1100 Nm
2. MECHANICAL ADVANTAGE: 3.83
3. RATIO: 4.5:1
4. DIMENSIONS: IN [MM]
5. OUTPUT FLANGE: ISO F16

	A24S	A24R
STEM NUT	STEEL	BRONZE
THRUST	-	240 KN
'A' MAX	22	-
'B' MAX	90.4	-
∅ 'C' MAX	85	70



COSTRUZIONI MECCANICHE LEGNANESI

MASTERGEAR

DIVISION OF REGAL-BELOIT CORPORATION
5466 EAST ROCKTON RD. · SOUTH BELOIT, IL 61080

THIS DRAWING/DESIGN IS THE PROPERTY OF MASTERGEAR. AND MUST NOT BE USED WITHOUT THEIR SPECIFIC WRITTEN CONSENT. ©

DO NOT SCALE
APPROVED BY
LD

DRAWING No.
A24 ISO
REV.0
16-04-03